

Autor:	Carlos González Santamaría
Nivel de dificultad:	Medio
Número de piezas:	8
Forma de las piezas:	Cuadrados

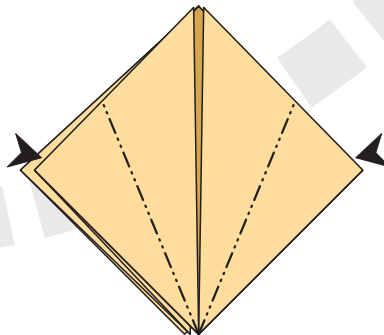

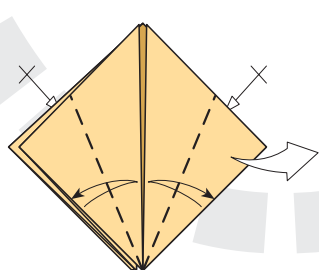
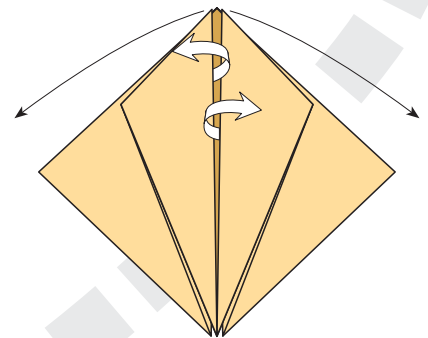
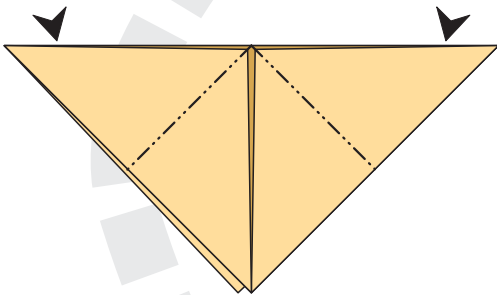
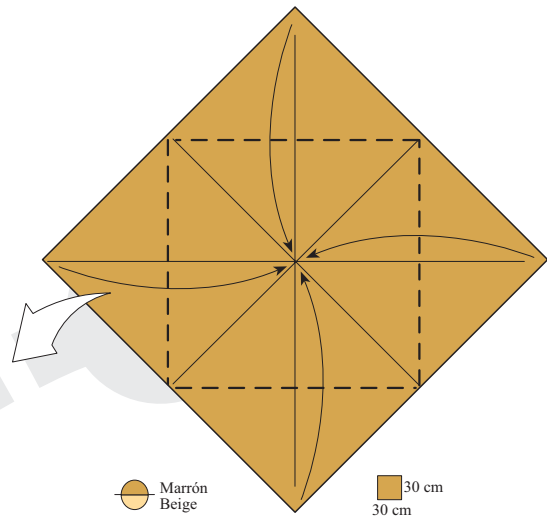
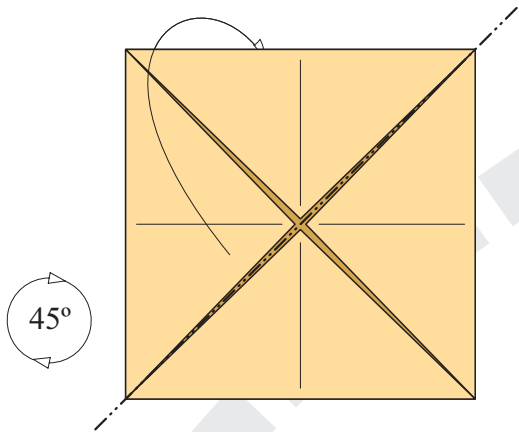
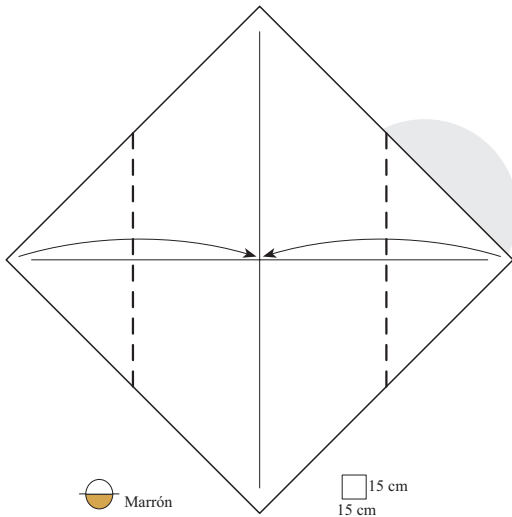

Marrón

15 cm
15 cm

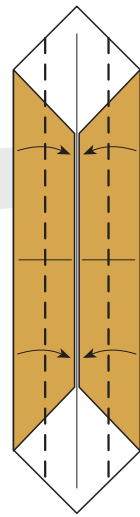
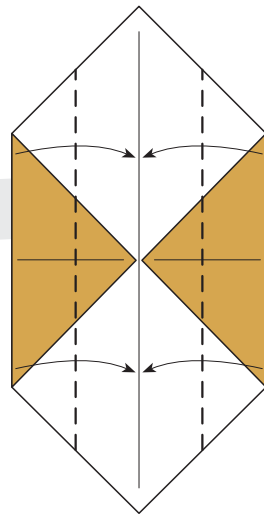

90°

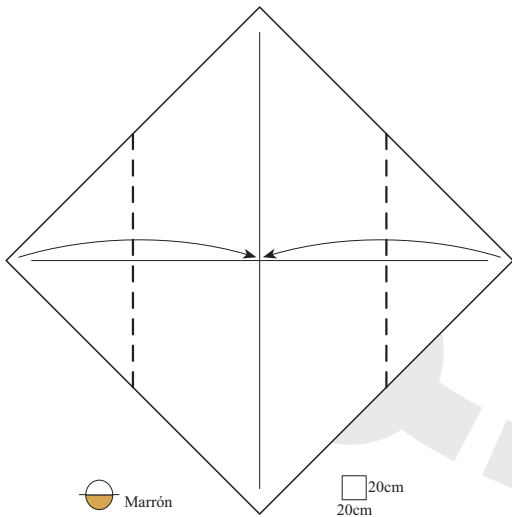
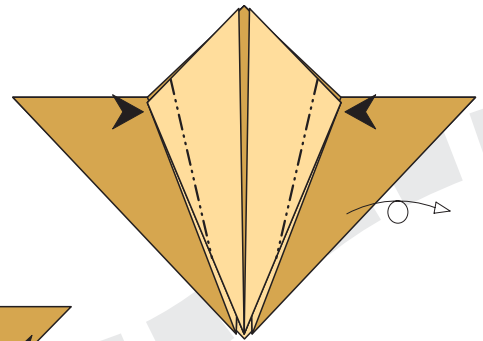
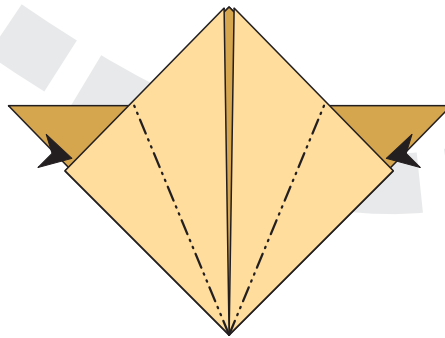
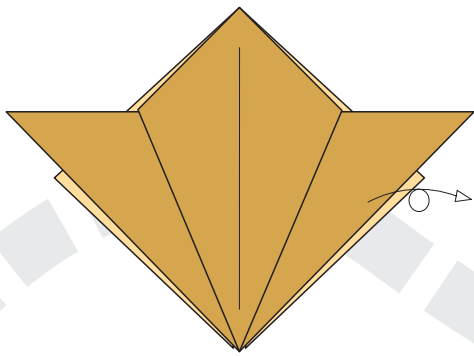

Marrón

20cm
20cm

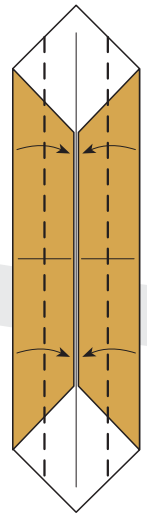
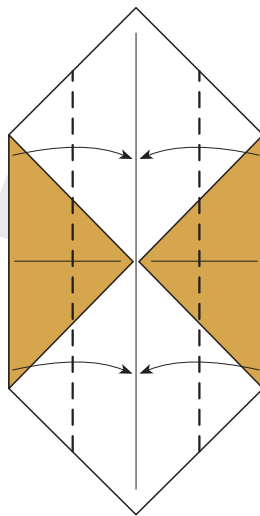

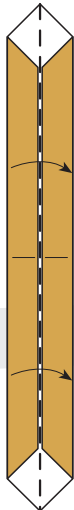
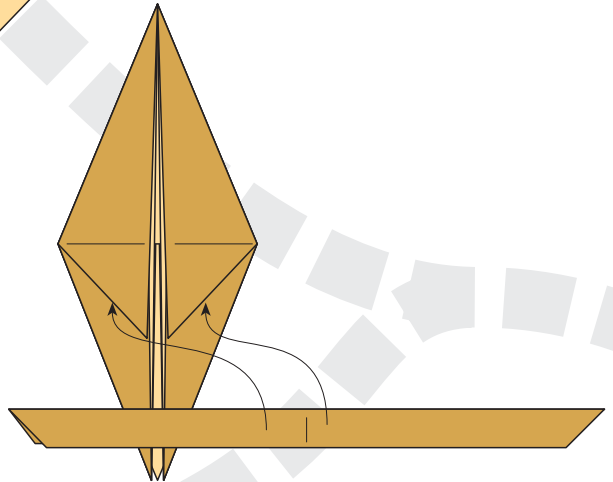
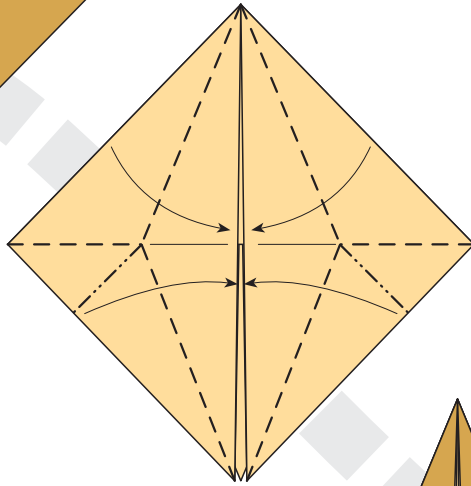
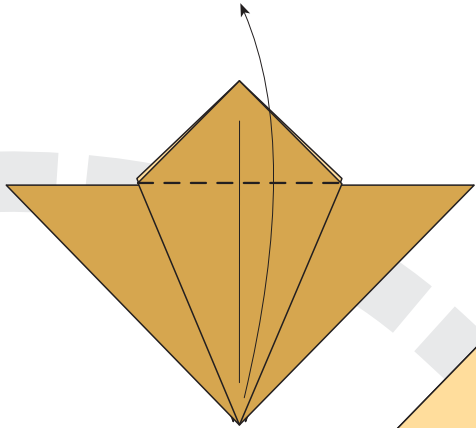
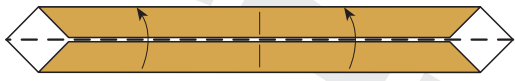

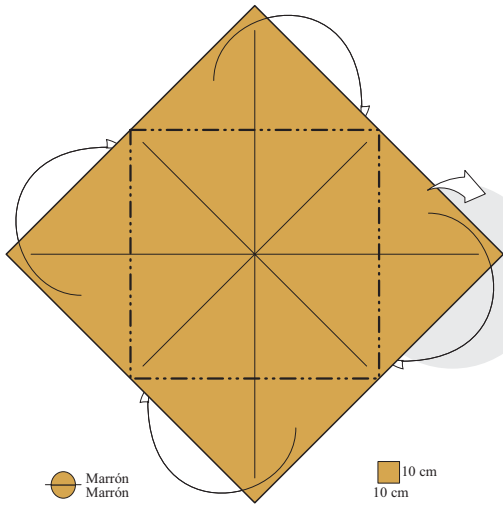

Marrón
Marrón

10 cm
10 cm

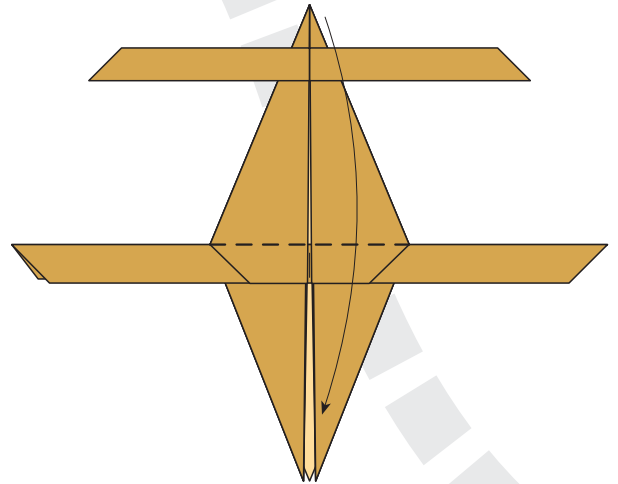
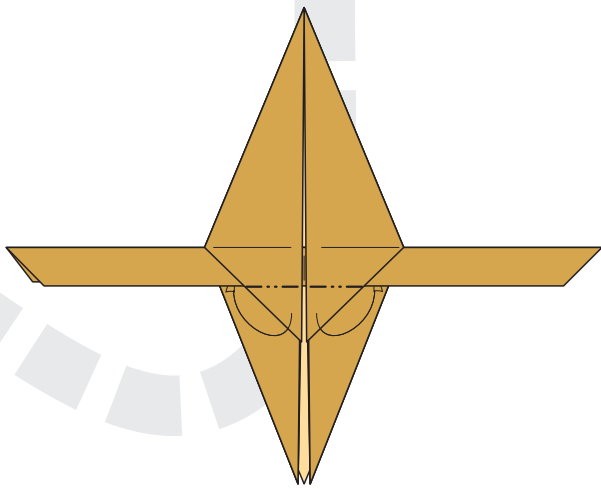
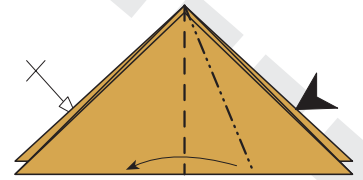
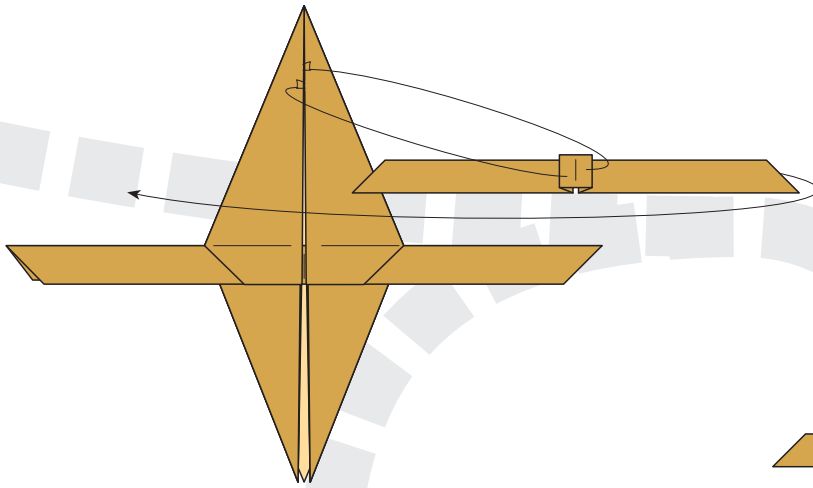
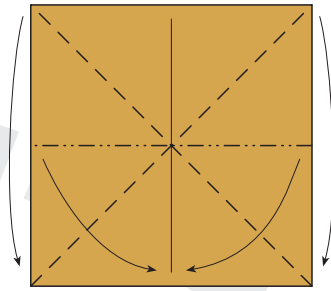

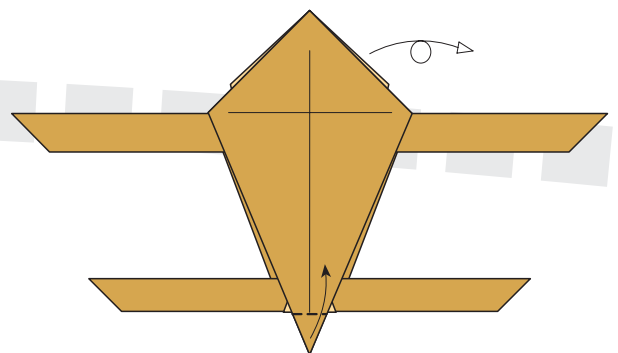
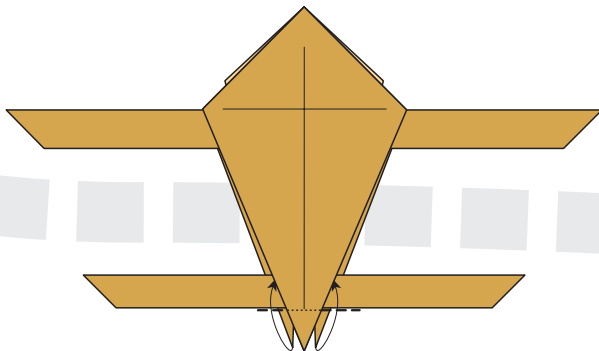
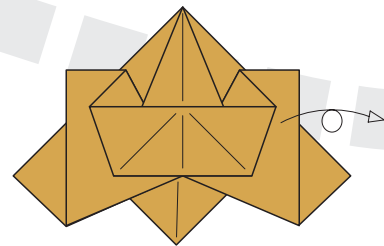
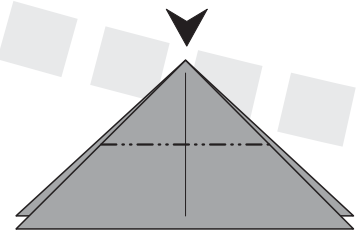
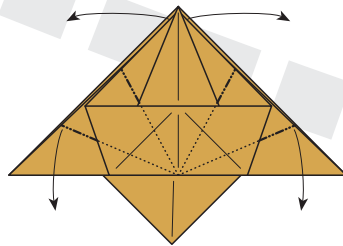
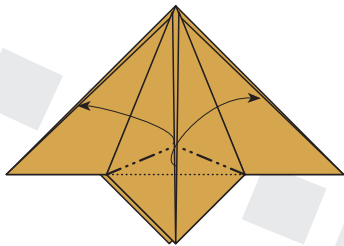
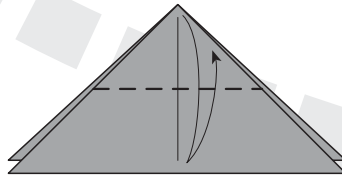
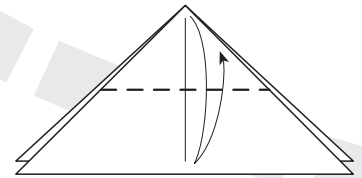
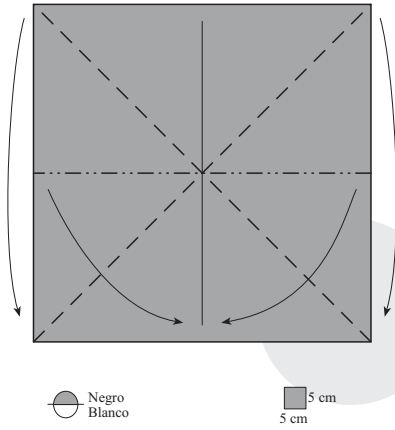
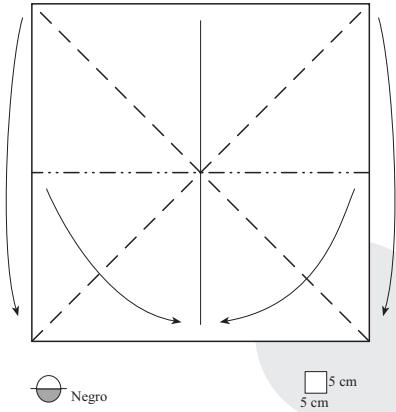

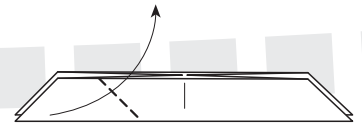
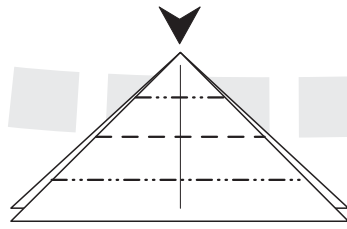
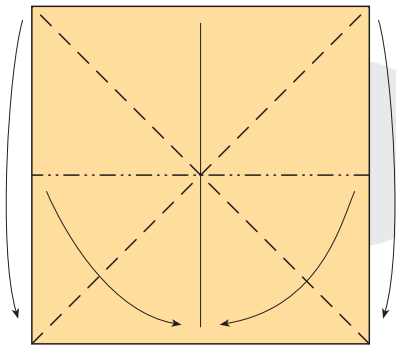

Blanco

5 cm
5 cm

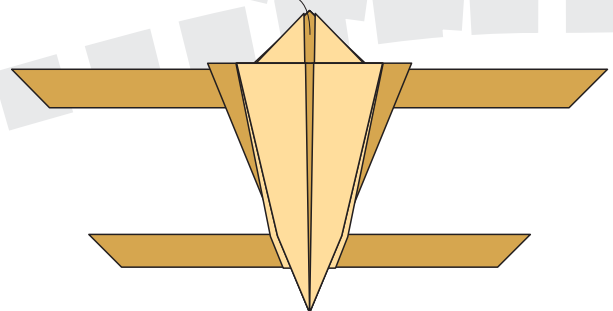
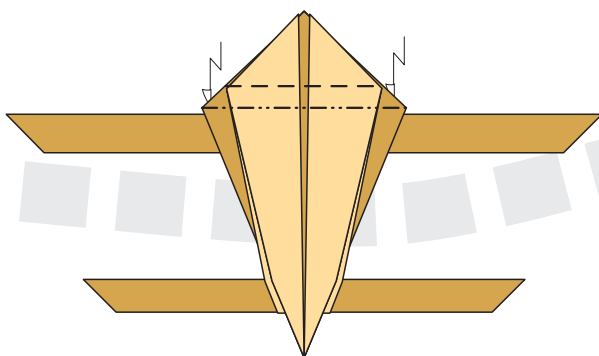
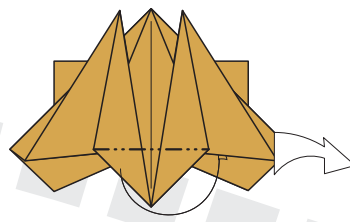
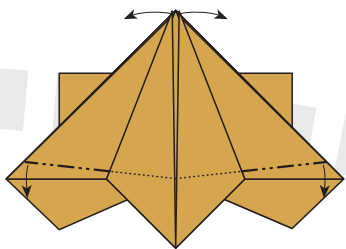
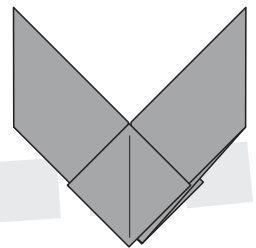
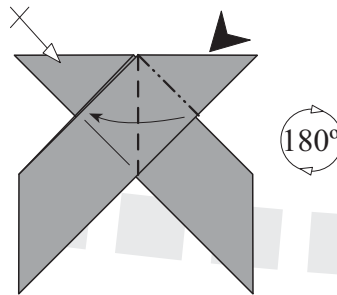
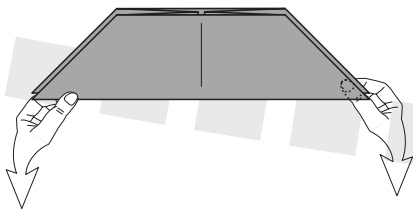
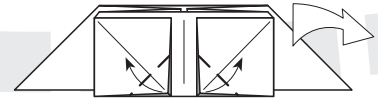
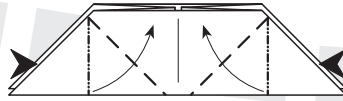
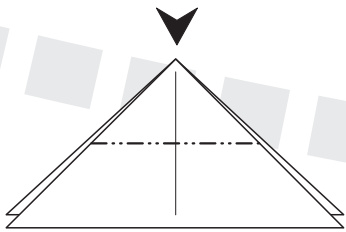

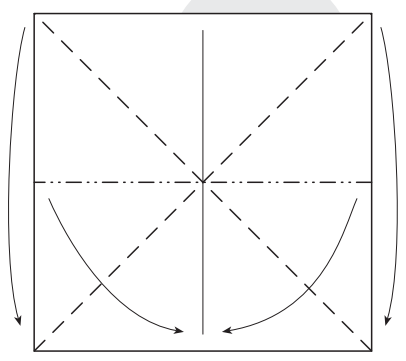
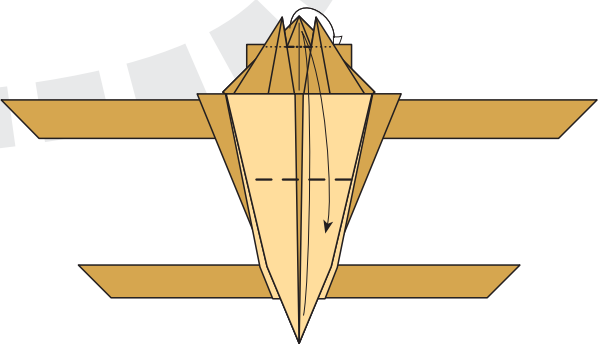
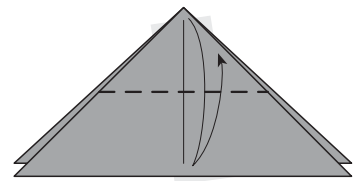
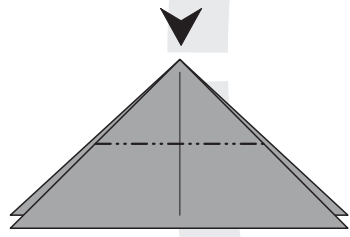
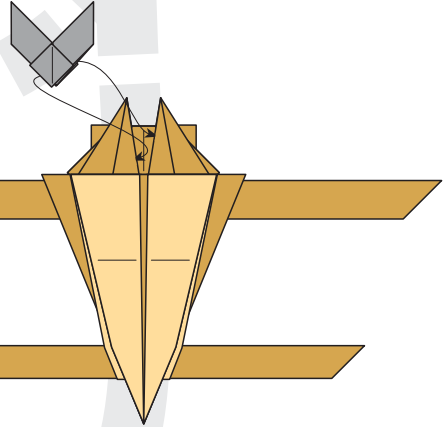
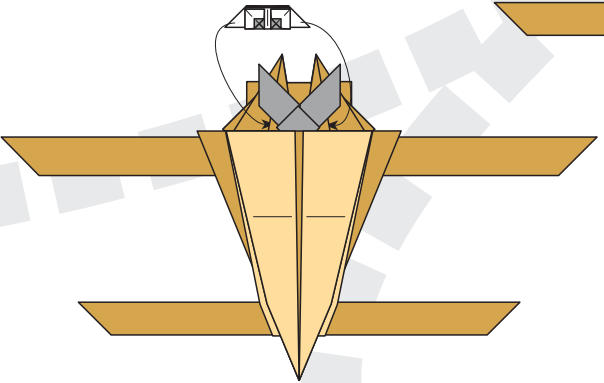
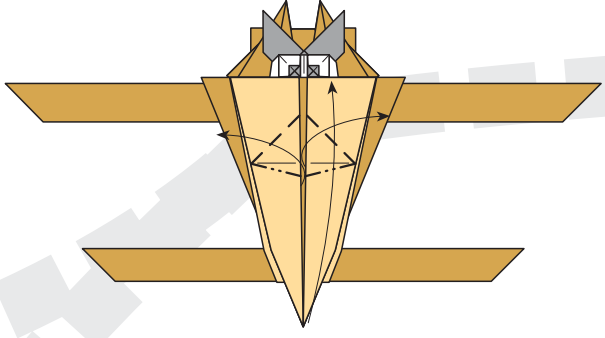
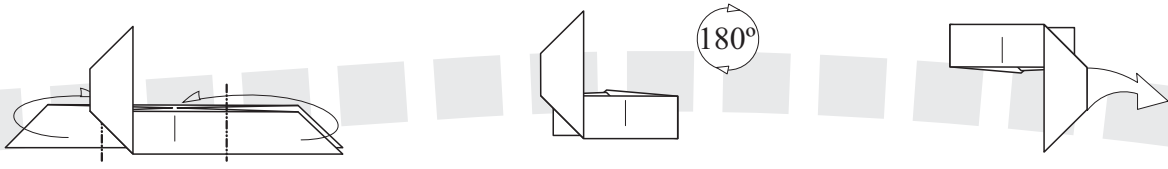

● Negro

□ 5 cm
5 cm

